

Attachment A

Draft Haymarket and Chinatown Revitalisation Strategy



Draft Revitalisation Strategy
August 2023

Haymarket and Chinatown



Contents

Introduction	4
Community engagement	10
Precinct context	14
Community vision	40
The City's approach	42
1. Renewal of the heart	44
2. Planning and heritage	48
3. Public domain and art	56
4. Culture, events and activation	58
5. Collaboration and partnerships	66

Figure 1

Images of Haymarket: (cover) Neon Playground event, (opposite page) Lunar New Year. Source: City of Sydney.



Message from the Lord Mayor

[Message to be added]

Figure 2

A photo of a street performance at a Sydney Streets event, at the intersection of Little Hay Street and Dixon Street. Source: City of Sydney.



Introduction

Welcome to Haymarket

Haymarket is one of Sydney's most iconic urban villages and has long been recognised as a focal point for Asian food, cultures, and communities both locally and internationally. Haymarket is a CBD activity hub offering a vibrant and unique urban experience, being both part of Central Sydney as one of the City's growing residential neighbourhoods accessed by two light rail lines.

The precinct is home to significant landmarks including Dixon Street (marked by the Chinatown gates), Market City and Paddy's Market, the Chinese Garden of Friendship and Belmore Park. Haymarket is a well-known destination for entertainment and nightlife and is home to the Capitol Theatre and the famous Sydney Lunar New Year festival and the Friday night markets.

The area is of particular significance to the Chinese Australian community. Chinese people began arriving as early as 1818. By the 1920s, the Haymarket area became the social, cultural, and economic centre for Chinese in New South Wales, who were mostly Cantonese speakers.

The area became known as Chinatown in the 1970s and was gradually promoted as a tourist destination.

Over time, Haymarket's population has diversified through immigration from Mandarin-speaking regions of China and South East Asia. Thai Town has emerged around George and Campbell Streets. In addition to being highly diverse, the population is younger than elsewhere in the city.

Haymarket is characterised by the prevalence of Asian businesses, vibrant lighting and signage, and busy street life. In terms of the built form, Haymarket differs in character from elsewhere in Central Sydney, being fine grain ownership with narrow frontages, small/irregular plots, and with the diversity of heritage and building forms, including the prominent market buildings.

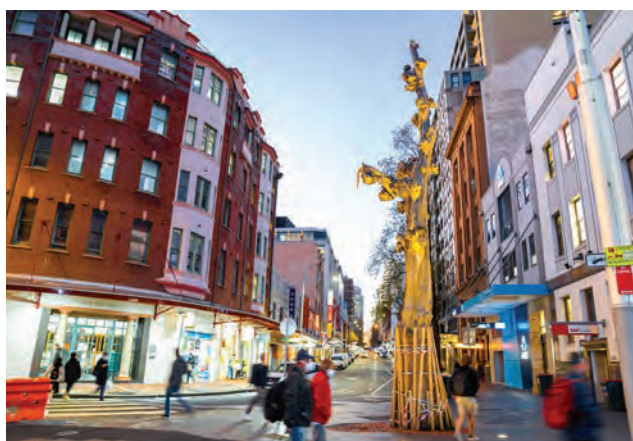

Figure 2
Images of Haymarket: (top) Lunar New Year (middle) Sussex Street (bottom) Hokkien Huay Kuan Arts Group in Belmore Park. Source: City of Sydney

Figure 3

A map of the Haymarket area showing key places. While the lived experience of Haymarket may extend beyond this boundary, the dashed line denotes the focus area for this draft revitalisation strategy. Source: City of Sydney.



Why we need to focus on revitalisation

The Haymarket economy has been impacted by competition from suburban East Asian precincts, limited investment in renewal, and a changing audience with different expectations. These issues were exacerbated greatly by the Covid-19 pandemic, lockdowns and the loss of international students and workers, and tourists. These factors have contributed to high retail vacancies, fewer people coming to the area and an increasingly dated presentation of parts of the precinct in comparison to the more recent Darling Square.

The City has been building a stronger understanding of the issues and opportunities facing Haymarket through undertaking:

1. Haymarket visioning engagement - hearing from more than 1,150 people
2. Haymarket and Chinatown Economic Study
3. Chinatown Thematic History

Local residents, workers and visitors have expressed that they would like to see Haymarket revive and become a vibrant and bustling place that celebrates diverse Asian cultures, a place that preserves its history and character while embracing contemporary forms of cultural expression.

Partnerships

In our conversations, we've met lots of passionate people who are doing their part in making this vision become a reality. The City will support, enable, and partner with local communities in their efforts to revitalise Haymarket and Chinatown. We recognise that there is no silver bullet, but that a wide-ranging set of actions is needed to catalyse positive changes in the area. Collaboration will be essential with local businesses, landowners, community groups, business chambers, cultural organisations and NSW Government.

The City's approach

The engagement feedback and evidence base has directed us towards a five-point plan to support the revitalisation of Haymarket:

1. renewal of the heart
2. planning and heritage
3. public domain and public art
4. culture, events and activation
5. collaboration and partnerships

The City proposes to intensify its focus on Haymarket for a three to five year period to introduce changes which can become self-sustaining.

What the City is already doing

Many actions are already underway including:

- recent public domain upgrades have been made to George Street, Thomas Street, Hay Street and Ultimo Road
- design work is underway for the upgrade of Dixon Street's public domain
- a heritage assessment and upcoming restoration of the Chinatown gates
- City's grants program supports creativity, businesses, innovation and to help put on festivals and events such as Neon Playground
- fees are waived for outdoor dining until 2025
- annual production of Sydney Lunar New Year, and twice annual Sydney Streets events
- funding and an accommodation grant for the creation of the new Museum of Chinese in Australia (MOCA), due to open in 2023/24
- supporting SXSW Sydney which will be based in Darling Harbour and Haymarket in 2023



Figure 4
A photo of Kimber Lane and the public art installation *In Between Two Worlds* by Jason Wing.
Source: City of Sydney.

Strategic directions

This Revitalisation Strategy aligns with the direction set by other City's strategies, including:

- *Sustainable Sydney 2030-2050 Continuing the Vision* (The Vision) guides the City's efforts to improve the way communities live, work and play.
- The *Central Sydney Planning Strategy* is a 20-year growth strategy for the economic powerhouse of the nation, hosting more than 12,600 businesses in a mixed economy. It revises previous planning controls and meets our Sustainable Sydney 2030 goals for a green, global and connected city. Through 10 key moves, the strategy balances opportunities for development capacity to meet the demands of growing numbers of businesses, workers, residents and visitors and their changing needs. It was accompanied by a new Contributions Plan to fund local infrastructure to transform Central Sydney.
- *City Plan 2036*, the City's Local Strategic Planning Statement (LSPS), outlines 13 priorities and a series of actions to achieve the vision and guide future changes to the City's planning framework. The Plan integrates the City's plans and priorities across many strategies addressing culture, environment, cycling, economies, community, and sustainability.
- The *Public Space Public Life Study 2020*, prepared by Gehl Architects in collaboration with City of Sydney provides an review of Sydney's public life. It reports that the City must continue to increase the quantity and quality of well-planned streets and spaces that are human in scale, sustainable, social, healthy, safe, and lively.

STRATEGIC DIRECTIONS



Sustainable Sydney
2030-2050
Continuing the Vision



Central Sydney
Planning Strategy
2016-2036



City Plan 2036
Local Strategic
Planning Statement



Public Spaces
Public Life Study
2020



PRECINCT PLANS



A Community
Vision for
Haymarket

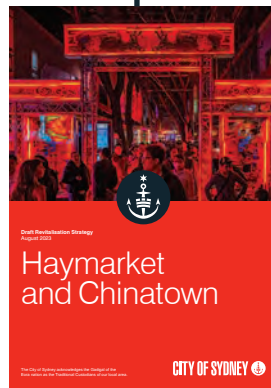

Haymarket and Chinatown
draft Revitalisation Strategy



Haymarket Public
Domain Plan

EVIDENCE BASE

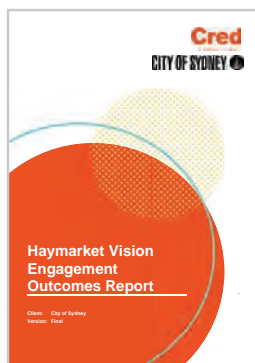

Haymarket Vision
Engagement Outcomes
Report (2022)



Haymarket and Chinatown
Economic and Land Use
Study (2023)

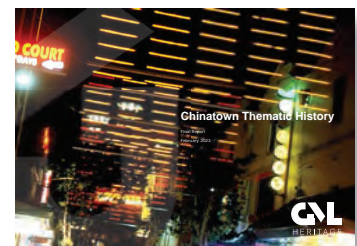

Chinatown Thematic
History (2023)

Community engagement

Wide ranging engagement was carried out between August and October 2022 to understand what makes Haymarket special, the places that people love and what could be improved.

More than 1,150 people shared their ideas for the future of Haymarket

Over 950 community surveys were completed in English, traditional and simplified Chinese, Thai, Korean and Indonesian. Around 110 people attended the Lord Mayor's forum in August 2022. Six pop ups were held across the area and meetings were held with stakeholder groups in the area. *Community Vision for Haymarket 2022* was prepared with this extensive input from the community.

Community representatives spoke as cultural custodians. They expressed a great of sense of responsibility for the future of Haymarket and a desire to work together with the City of Sydney.

Below is a summary of the feedback from the survey.

People described Haymarket as:

- known for Asian restaurants and shops (90%)
- a place to meet friends and to go out (58%)
- having a busy street life (55%)
- a destination for tourists and visitors (54%)
- a place where you see diverse cultures reflected on the streets and public spaces (53%)

The special places in Haymarket include:

Dixon Street (33%) and Chinatown (18%)

- a place to find diverse, affordable and authentic food offerings
- a place of significant cultural heritage and history

- a place of cultural belonging and experiences
- the Gates on Dixon Street are welcoming and culturally symbolic
- Dixon Street is the heart of Chinatown

Paddy's Market (21%)

- offers a convenient and affordable shopping experience
- place people feel connected to through past experiences and memories
- a cultural institution in the centre of Haymarket

Darling Quarter (18%)

- great range of restaurants and bars
- a lively, vibrant and safe space to socialise both day and night
- a clean, green and modern space to connect with family and friends

Market City (11%)

- a unique place for shopping
- diverse and affordable food options
- fun place to meet with friends and families

Emperor's Garden Cakes and Bakery (7%)

- delicious, unique and affordable dessert offering in Chinatown
- an iconic food institution in Chinatown

Thai Town

- identified through stakeholder meetings rather than the survey



Figure 5
People give their views about the future of Haymarket at pop up event, September 2022. Source: City of Sydney.

The most important factors for the future of Haymarket include:

- good food options (84% of respondents rated this as very important)
- being culturally diverse, welcoming and safe (82%)
- being pedestrian friendly and easy to move around (81%)
- expression of Asian cultures throughout the precinct (74%)
- respecting and celebrating the social and cultural history of the area (72%)

Respondents identified the following priorities for improvement for Haymarket overall:

- more lighting to create a safe and colourful atmosphere
- greater range of quality, authentic and affordable food and retail options
- more outdoor dining options and public amenities like seating and public toilets
- improved access to and connections within Haymarket
- increased attractiveness of the area through street cleaning and maintenance
- contemporary cultural expression
- preservation of local character and cultural heritage
- using the streetscape to bring colour and to celebrate diverse Asian cultures
- extended trading hours and thriving nightlife

Respondents identified the places that should be improved, including:

Chinatown (63%)

- revitalise Chinatown to attract more people to the area
- improve cleanliness and maintenance
- increase food and retail offerings
- install creative lighting

Dixon Street (36%)

- improve building maintenance to beautify Dixon Street
- install more lighting

Paddy's Market (11%)

- improve food and retail offerings
- revitalise Paddy's Market and the space
- make comparable to world-class markets in other cities

southern end of George Street (9%)

- better activation of George Street
- increase greenery

Sussex Street (9%)

- improve pedestrian experience
- improve cleanliness
- improve food and retail offering

Belmore Park (6%)

- a more welcoming and accessible space
- improve lighting

Figure 6

People give their views about the future of Haymarket at the Lord Mayor's forum, August 2022. Source: City of Sydney.



Precinct context

Connecting with country

Haymarket is the traditional lands of the Gadigal. Prior to European occupation the upstream waters of Darling Harbour / Tumbalong was fed by two freshwater streams: one that ran down from what is now George Street, along Hay Street, and the other coming in from the south.

On the eastern foreshore of Darling Harbour/ Tumbalong, there is archeological evidence of Aboriginal occupation in the years before and after European invasion, including shell middens. An 1813 engraving (Figure 7) shows an Aboriginal camp site on the shores close to the site of the present-day Chinese Garden of Friendship, and Aboriginal fishing canoes on the water behind. This activity likely continued until the beginning of industrialisation in the 1820s and 30s.

The City's Stretch Reconciliation Action Plan 2020-23 recommends that the City recognise Aboriginal and Torres Strait Islander histories, cultures and achievements in Sydney through the Eora Journey: Recognition in the Public Domain. This project, overseen by art curator and writer Hetti Perkins with Emily McDaniel, aims to reactivate the knowledge of specific places and events in Aboriginal history at key sites in the city.

The City's Barani website <https://www.sydneymarani.com.au/> identifies the location of places that have historical associations for Aboriginal and Torres Strait Islander people in Sydney. A number of sites are located in Haymarket, including:

- The Trades Hall (4-10 Goulburn Street). Unions supported Aboriginal people to access employment and scholarship opportunities and supported political lobbying for Aboriginal rights.
- Foundation for Aboriginal Affairs Headquarters (810-812 George Street). Opened in 1966, the headquarters provided welfare support and

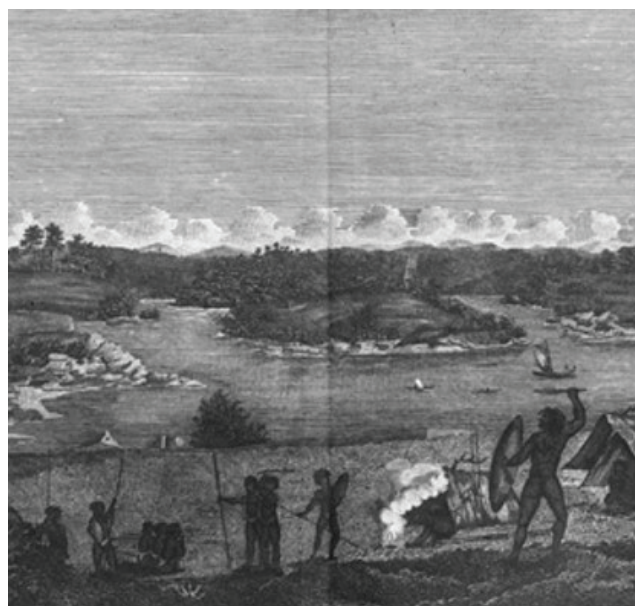

Figure 7

The earliest view of Cockle Bay drawn by John Eyre c1813. Source: www.darlingharbour.com/editorials/history-and-heritage

was a popular venue for community functions.

- Burlington Hotel (431-439 Sussex Street). In 1965 a sit-in demonstration was held here protesting the hotel's policy to refuse admission to Aboriginal patrons.

The City is also investigating ways to implement 'Connecting with Country', including a specific focus on Aboriginal and Torres Strait Islander artists and cultural expression.

An LGA wide Aboriginal Cultural Heritage Study is being scoped to build on Barani's strong base of research and further extend the mapping of stories and sites. This will involve community engagement and historical research, and will identify opportunities to embed connections with Country into future plans and projects.

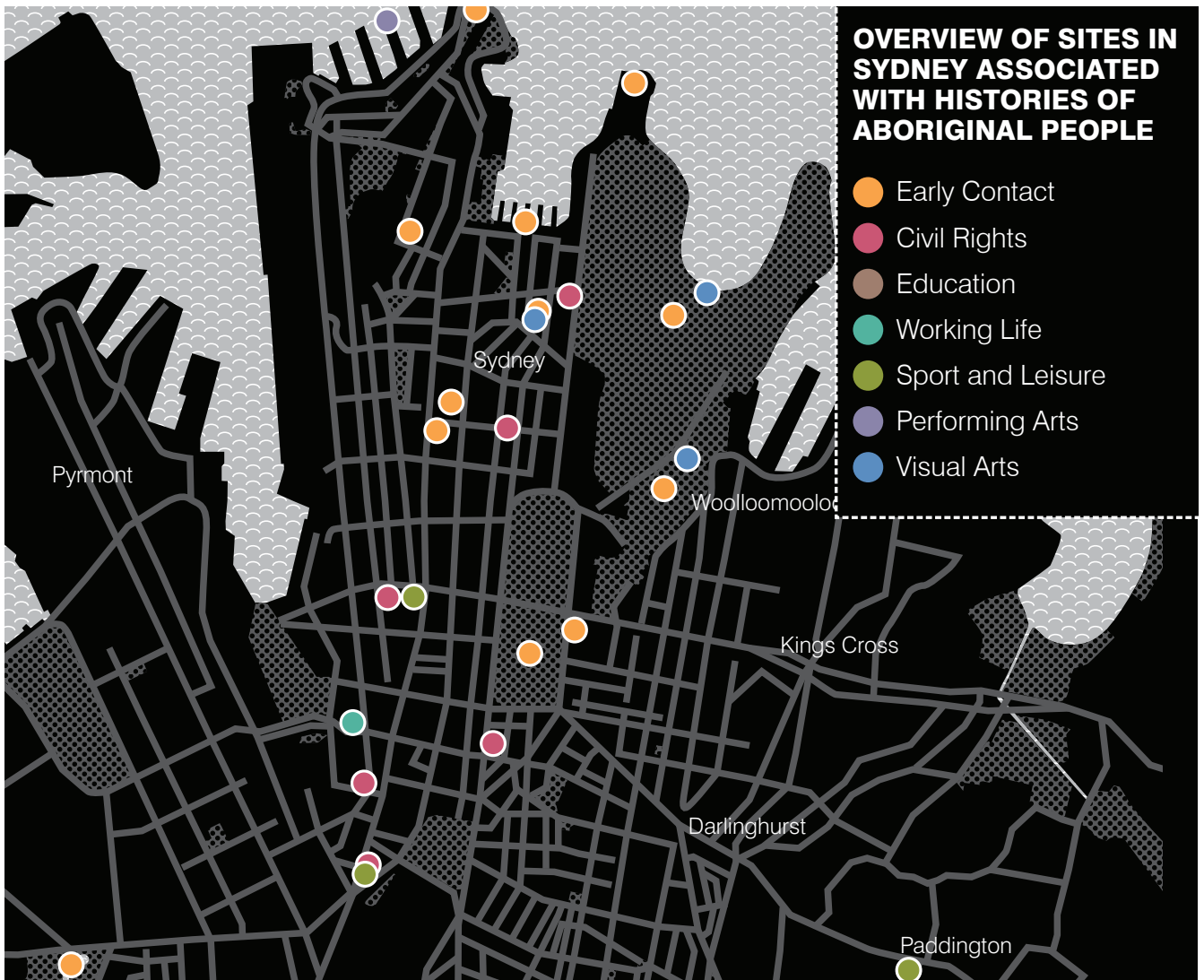

Figure 8

A map of sites in Sydney in association with histories of Aboriginal people. Source: Barani / Barrabubu (Yesterday / Tomorrow): Sydney's Aboriginal Journey

Haymarket's history

>65,000 years ago

For what is now known as Haymarket, the area has a long and rich Aboriginal history. Evidence of campsites and tool-making show that the area has been inhabited for more than 65,000 years.



1815

Newly arrived engineer John Dickson was granted 15 acres on Cockle Bay, on which he built a new flour mill, and installed Australia's first steam engine in 1815. From these roots, Darling Harbour grew as an industrial location. It is thought Dixon Street was later named after him.



1788-1800

The arrival of the First Fleet devastates Aboriginal society around Sydney Harbour and the broader region.

A British settlement is established in Sydney.

1830-1900

Proximity to the markets proved attractive to small manufacturing, with buildings used as temporary boarding houses for itinerant traders. The Haymarket is subdivided and settled. In 1842 the City of Sydney took over jurisdiction of the markets.

thousands of years

Haymarket is inhabited by the Gadigal, coastal people who relied heavily on fishing and shellfish gathering. The area was well provided for with two freshwater streams and Darling Harbour / Tumbalong.

1830

The edge of Sydney Town more or less coincided with Bathurst Street, excluding Haymarket. Being at the nexus between the town and countryside, Haymarket is established as a place for farmers to sell their goods.

1870-1900

Chinese people began arriving to Sydney as early as 1818. Waves of migration brought Chinese workers and fortune seekers at the end of convict transport system and during the gold rush. Earlier Chinese migrants settled around The Rocks.

The movement of the Chinese community into Haymarket begins in the 1870s, following the construction of new fruit and vegetable markets, known as the Belmore Markets. Chinese businesses spring up to serve as produce and market gardeners.



1890-1920

Haymarket continues to develop.

In 1893, Belmore fruit market building is built at the open air cattle markets between Campbell and Hay Street by the City of Sydney. This building was subsequently modified and leased to Wirth Brothers Circus between 1916 and 1927 for use as a Hippodrome. It was later used a picture theatre and adapted as Capitol Theatre.

Central Station is built in 1906.

Between 1909 and 1915, new produce market buildings are built by the City of Sydney in Hay Street. They were partly retained in 1997 and Paddy's rehousing in the Market City redevelopment.



1888

Haymarket becomes a centre for political activism. Trades Hall on Goulburn Street began construction in 1888 as a purpose-built facility for different trade unions to meet in the pursuit of common goals.



1920

By the 1920s, the area is a focus for the Chinese community. By comparison to the rest of the city, it is a relative safehaven from racial discrimination.

Societies or clan groups, known as Tongks are vital links to the home villages back in China and supported clan members with finance, translation and accommodation.



Figure 9

From left to right: Dove's plans of Sydney (map 42) 1880 Source: City of Sydney Archives; Fruit and vegetable markets c1920. Source: City of Sydney Archives. Chinese hawker, Sydney, c.1900s. Source: National Library of Australia, Star Photo Co.; Meeting of the Chung Shan Society, Campbell Street, 1910. Source: Private collection of Norman Lee; Sydney Chinese Dragon Ball, 1945. Source: National Library of Australia.



1980 - 1997

West Darling Harbour rail yards, shipping wharves and coal fired powerstations are redeveloped into a tourist destination, offering the entertainment centre, shopping centre and cultural institutions connected by a monorail.

The Chinese Garden of Friendship was created in a romanticised historical oriental style from the Ming dynasty.

The markets are relocated to Flemington in order to service a larger metropolis, and part of the market complex is redeveloped into Market City shopping centre with The Peak residential tower above.



1960 - 1980

The Dixon Street Beautification Committee is established to create a 'Chinese Centre'. 'Chinatown' is named and becomes a destination.

The end of the White Australian Policy in 1973 allows for more Chinese migration and the arrival of white collar workers.

Dixon Street is pedestrianised and decorated in an oriental style. The ceremonial gates are built.



1990

Chinatown becomes one of Sydney's top 10 tourist destinations.

1989

Waves of immigration to Australia, some resulting from the 1989 Tiananmen Square protests, see the rise of Mandarin-speaking Chinese people. In 2021, Mandarin speakers now outnumber Cantonese speakers 5:1.

1997

The transfer of Hong Kong's sovereignty leads to more immigration, Cantonese-style restaurants and large-scale development projects such as the Sussex Centre, Market City and Capitol Square.

1990-2007

World Square opens, with tall commercial, residential and hotel towers, with shops around an internal network of laneways.



2020-2022

The Covid-19 pandemic results in anti-China sentiment, lockdowns, and the forced loss of international students and tourists.

Some notable businesses close or relocate. Empty shops in the core Chinatown area increase more than in other locations.



2010-2019

There is a major redevelopment of the Entertainment Centre site and Darling Harbour. In its place, the new mixed use Darling Square precinct is constructed, drawing activity to the west of Haymarket.

Construction of light rail results in temporary disruption to businesses. Once built, it transforms George Street into a pedestrian boulevard, and establishes 'Chinatown' and 'Haymarket' stops.

2022

Community groups come together to support the recovery of Chinatown.

In November 2022, Soul of Chinatown, Haymarket Chamber of Commerce and Haymarket HQ partner to put on Neon Playground, supported by the City's Precinct Activation Grant. The 4-week festival results in a surge of activity.

2000-2020

Haymarket diversifies, with immigration from South East Asia. A cluster of Thai businesses form around Campbell Street.

Other Asian precincts in suburbs around the city centre improve in their food and retail offer. Places such as Hurstville, Burwood, and Chatswood become more self-sufficient.



Figure 10

From left to right: George Street 1970; Dixon Street (above) 1970 (below) 1985; (above) entertainment centre 1983 (below) Market City 2000; Thomas Street; Darling Square; Chinatown light rail stop; and Neon Playground event. Source: City of Sydney.

Diverse Asian village

Haymarket's identity and role has evolved over time. As its name suggests, Haymarket formed around a succession of markets.

Alongside European settlers, a cluster of Chinese businesses and boarding houses sprung up to serve Chinese market gardeners. In the 1920s, Haymarket became a place where Chinese migrants, mostly from Canton (Guangzhou), could send remittances (money) to family, speak Cantonese, play mahjong, have a familiar meal, purchase rare goods, gamble, practice religion, and socialise. International Chinese opera troupes toured, and martial arts schools trained students in activities such as lion dance troupes.

Tongs (Chinese societies or clan groups) played a vital role providing links to villages back in China, connecting people to others from the same province and supporting members with travel movements and immigration to Australia. These tongs became social places for members and resulted in strong community bonds. Tong buildings at Goong Yee Tong at 50 Dixon Street and You Ming Hung Fook Tong at 417 Sussex Street still stand today.

Over time, the demographics of those immigrating from China to Australia changed - from labourers sending money home to highly-educated workers and investors who choose to settle; and from majority Cantonese speakers to Mandarin speakers. This was partly due to China's economic growth and partly due to changes in immigration policy.

Second and third generation Chinese Australians have emerged with their own identity and culture - a unique fusion of their family origins and their birth country.

In the late 20th century, the economy in Haymarket saw significant change. The markets and industrial uses moved further out of the city

centre, freeing up sites for redevelopment.

'Chinatown' was coined and the area was transformed into a greater tourist destination with the Chinese styling of Dixon Street and the creation of the Chinese Garden of Friendship at 1 Harbour Street in 1988. Built on reclaimed land, the Garden were designed by Sydney's Chinese sister city, Guangzhou, having been advocated for since the 1970s by the community including local architect and politician Henry Tsang OAM.

With rising rents in Haymarket and a changing demographic, new migrants were more likely to cluster in the the suburbs of Willoughby, Eastwood, Burwood and Hurstville. Despite this, Haymarket remained a special place for Chinese Australians to come in from the suburbs to celebrate Chinese New Year, visit Yum Cha banquets on special occasions and buy specialty food or goods which were hard to get elsewhere.

The population of Chinatown and Haymarket has continued to diversify, with more migrants from different parts of China and Asia.

In 2022, residents' countries of birth include China (21%), Thailand (17%), Australia (13%), Malaysia (3%) and South Korea (3%). Being near to the Universities, international students from a variety of Asian countries often come to Haymarket to seek out familiarity and 'a taste of home'.

This co-location of different East Asian communities is relatively rare; Chinatowns elsewhere in the world have not attracted such a diverse mix - such as Thai businesses clustering around George, Campbell and Pitt Streets.

From this diverse Asian village, a distinct Asian Australian identity has emerged. Haymarket now still offers a sophisticated range of both traditional / authentic and contemporary / fusion food, art, and culture.



Figure 11

Images of Haymarket. Clockwise from top left: Grand Thai Festival, Darling Square Library, a Ramen restaurant on Campbell Street, Lunar New Year 2023 and Darling Square. Source: City of Sydney.

There are a diversity of places within Haymarket with different characteristics and activities.



1 - Core Chinatown area

In Precinct 1, the Chinatown area of Haymarket is centred around Dixon Street and extends out towards Sussex, Hay, Harbour and Liverpool Streets. For many people, the lived experience of Chinatown extends beyond this core area.

Chinatown is a cultural centre, now at the heart of a diverse Asian village. It is a place of significant cultural heritage and history, a place to find diverse, affordable, and authentic food offerings, and a place people feel connected to through past experiences and memories.

The area is characterised by a density of smaller buildings, land ownership and businesses, and high concentration of food and beverage operators. Chinatown has historically been a major visitation drawcard for both domestic and international tourists. It plays a predominantly hospitality-orientated role to price conscious students and tourists.

The economic study found that the core Chinatown area has experienced the largest decrease in activity levels (comparing 2019 to 2022) and has the highest ground floor vacancy rates. Engagement findings told us Dixon Street and Chinatown are highly valued and the highest priority for improvement.



2 - Darling Square

On the former Entertainment Centre site in Precinct 2 immediately south of Darling Harbour, the newly developed 'Darling Square' was completed in 2019. The development provides highrise apartment buildings, commercial office buildings, a 4-star hotel and the 'Exchange' public library arranged adjacent to the green square.

Darling Square has a popular food, beverage and retail offering, with some businesses having relocated from elsewhere in Haymarket. Being under one landowner, the offer is curated and is better meeting the expectations of younger audiences. The precinct's food and beverage offering is generally at a higher price point compared to historic Chinatown. It serves a mix of residents, workers and visitors, including families. Darling Square has the lowest vacancy rate in Haymarket.

The addition of Darling Square has drawn some activity away from historic Chinatown.

Being new, it has also made the presentation of Chinatown seem run down by contrast. There is an opportunity for historic Chinatown and modern Darling Square to be better connected and to complement each other.



Figure 12
 The economic study area considered the differing character and role of seven sub-precinct within Haymarket. Source: Location IQ.

3 - Kent and Sussex Streets

Precinct 3 has been a natural northward extension of Chinatown shops and activities. It includes a mix apartment buildings, hotels and commercial buildings with a diverse mix of Asian-orientated retailers. It is anchored by the Events Cinema on George Street and Regent Place, a modern, food and beverage orientated shopping arcade at the base of two-high rise apartment buildings.



4 - Koreatown

This area includes a mix of commercial office buildings, hotels/serviced apartments and modern apartment buildings, within taller and denser buildings.

Precinct 4 is located centrally within Sydney's CBD, the area mainly services CBD workers and residents. It has the second highest worker density and value added. It has a few Korean restaurants, cafes, karaoke bars and retailers and has been called 'Koreatown'.



5 - World Square

Precinct 5 is located between Goulburn, George, Liverpool and Pitt Streets, World Square is a modern shopping centre offering over 16,500sqm of retail floorspace, with residential, commercial and hotel towers above. It is anchored by a major supermarket, multiple national retailers and food court. Aligning with the rest of Haymarket, the offer includes Asian shops and restaurants.

As a major shopping destination in the Sydney CBD, World Square services a relatively young demographic and includes a broad mix of CBD students, visitors and CBD workers. It has the highest worker density and value added within Haymarket.



6 - Thai Town

The Thai Town area centres on Campbell Street, and extends out towards Goulburn, Castlereagh, Hay and George Streets. The City officially identified Thai Town in 2013 as one of a few Thai Towns in the world. Thai is the third most spoken language by Haymarket residents, after Mandarin and English, and Thai ancestry is identified by 16.2% of Haymarket residents.

In Precinct 6, Campbell Street, at the heart of Thai Town, has a high concentration of Thai restaurants, grocers and specialty retailers, and offers contemporary fusions of eastern and western flavours. It has hosted several cultural events, including the Lunar New Year Festival, where road closures welcome people onto the street. There is an opportunity to reinforce the identity of Thai Town through the signage and design of the public domain and public art.

Thai Town includes several major hotels, commercial office buildings and the Federal Circuit and Family Court of Australia. The Capital Theatre and Capitol Square are a major attractor. The area functions as key dining, entertainment and commercial precinct and services a broad mix of tourists, CBD workers and residents.



7 - Market District

The historic market district of the Sydney CBD extends south from Hay Street to Central Station, taking in Paddy's Market, Thomas Street, Ultimo Road and a section of George Street.

The Paddy's Market and Market City building is a historic landmark and key attractor to the area. However, the market stalls have struggled with high vacancy rates in recent years and was severely affected by Covid-19.

The Precinct 7 area includes a broad mix of Asian retailers, restaurants, grocers in addition to several commercial office buildings and apartment buildings. The area attracts tourists and also plays an important role in servicing the three neighbouring university campuses to the south.

This area has experienced the second largest decrease in activity levels (comparing 2019 to 2022) and has the second highest vacancy rates.

Economic research findings

City Planning commissioned the *Haymarket and Chinatown Economic and Lane Use Study* to review economic change, occupancy, business trends and provide an overall economic 'health check' of the area. The study sought to understand the impact of recent changes, as well as the acute impacts of the Covid-19 pandemic on Haymarket's local economy.

Food catering remains the predominant activity

An audit of Haymarket's ground floor retail space found that food catering remains the predominant activity. This coincided with the community feedback; 91% of survey respondents go to Haymarket for the restaurants and cafés.

The proportion of food catering businesses was particularly high in and around Dixon Street.

The vacancy rate is high

The vacancy rate in Haymarket at ground level was very high (18.3%) and had increased significantly since 2017 (8.5% up from 9.8%). The vacancy rate was also higher than elsewhere in Central Sydney (6.9%) at the point of measure. For reference, 'healthy' vacancy rate would be between 3% to 5%.

The rising vacancy rate has been driven by a number of factors including the impact of a severe loss of customers due to Covid-19 on businesses, overall declining activity and visitation levels and unrealistic rent expectation by landowners.

If this persists, Haymarket's vacant space will threaten the retail future of Haymarket as visitor perceptions become engrained. The highest vacancy rates are in the Dixon Street and core Chinatown area, potentially opening up an opportunity for reinvention.

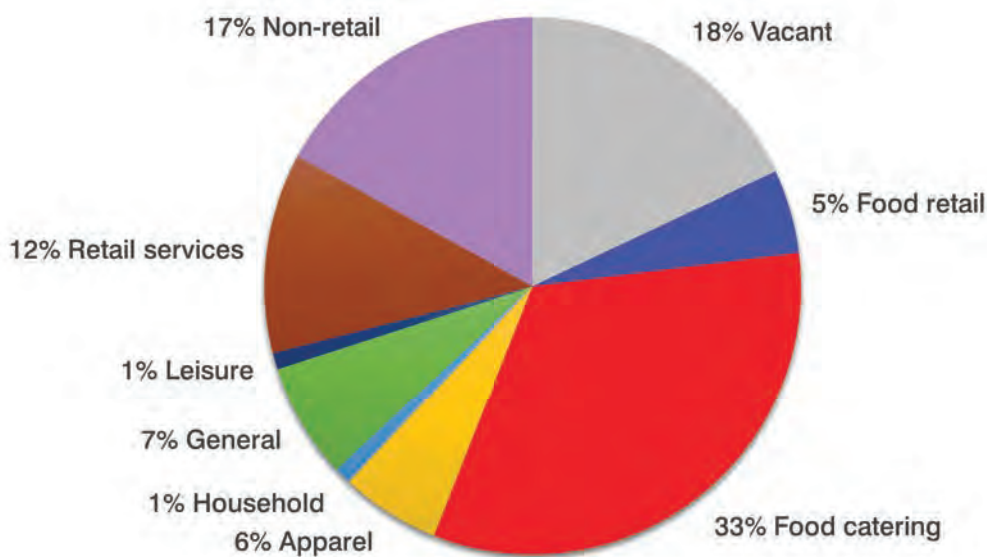

Figure 13

Ground floor businesses by property category (September 2022), Source: Location IQ.

	Haymarket	Central Sydney
weekday	-40%	-33%
weekend	-29%	-18%

Figure 14
Average daily user activity as a percentage difference between 2019 and 2022. Source: Roy Morgan.

The amount of retail floorspace is supportable - quality of the offer is the issue

However, despite the high vacancy levels, an analysis of the amount of retail floorspace compared to the trade catchment found that the amount of retail space was supportable, but it was the quality of that retail offer that is an issue. Authentic, immersive experiences in attractive settings have become the 'baseline' expectations in a post pandemic environment. Beyond Darling Square, there has been limited reinvestment, leaving Haymarket failing to meet customer expectations.

Activity levels are recovering

In 2022, activity levels in Haymarket were recovering but still below pre-pandemic levels (65% of 2019 levels). From mapping of mobile phone activity, we can see that activity is focused around Central Station, World Square, Darling Square and George Street. Activity is much lower around Dixon Street.

Haymarket's recovery has lagged behind the wider CBD. This can be partially attributed to the loss of international students and visitors from Asia who had not yet returned in 2022 and are a significant part of Haymarket's visitor-base.

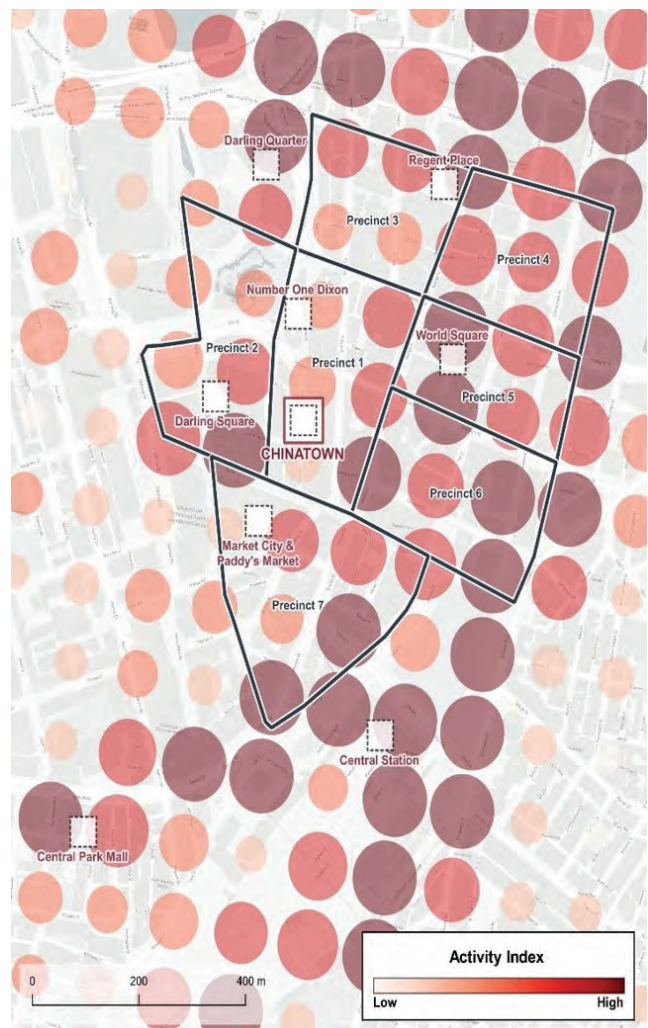

Figure 15
Weekend activity at 7pm, Q3 2020-Q3 2022. Source: Mapbox Movement.

On a more promising note, Neon Playground and Lunar New Year resulted in a marked increase in activity levels in Haymarket, demonstrating the potential of events and activations in revitalising the precinct. In 2023, activity levels have continued to gradually increase.

Demographics are changing

Haymarket has a large and growing resident population. Haymarket residents are younger, highly educated (44% have one or more university degrees), mostly single or unmarried couples (65.5%), with a high percentage of parents born overseas (84.2%). The most prevalent religion is recorded as Buddhism (27.7%), both within the Chinese and Thai communities.

Chinatown has diversified beyond its Cantonese roots. Mandarin (24.3%) has long since overtaken Cantonese (5.7%) as the most spoken language, and Thai (16.3%) and Indonesian (8.6%) speakers have also become more prevalent.

Haymarket's offer will need to adapt to meet the needs of a younger more affluent East Asian

population, who have divergent expectations from former populations. More youth orientated and specialty food and retail is in demand, alongside a vibrant urban life and experiences similar to those found in corresponding Asian cities.

International students are a key audience

Being near to University Technology Sydney, Notre Dame University, University of Sydney and TAFE Ultimo, an estimated 67,600 student tertiary and vocational students were located within and near to Haymarket pre-pandemic. International students are a key part of both the labour force and the customer base. We heard through engagement that international students from Asia visit the area for 'a taste of home'.

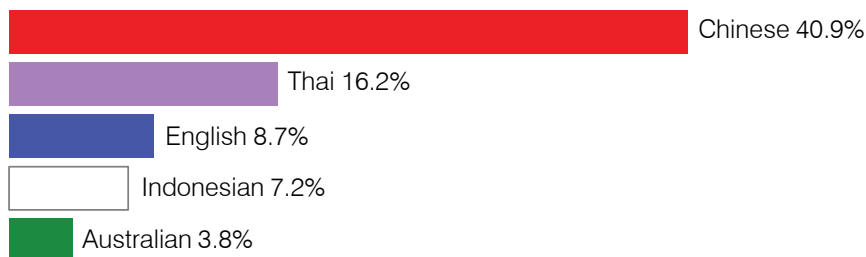

Figure 16

Haymarket ancestry. Source: Census 2021

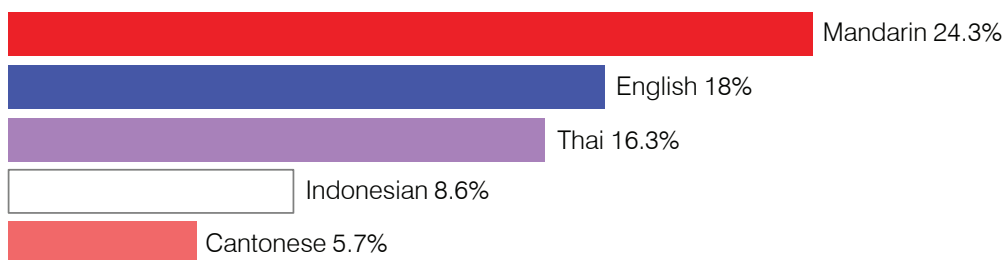

Figure 17

Haymarket language spoken at home. Source: Census 2021

Late night trading has declined

In the past, Chinatown had the reputation of being a late night destination. Haymarket is within a 'late night management area', which means that with approval from the City, businesses can extend their hours to operate 24 hours. However, the mobile phone activity data from 2022 showed there is a strong peak of activity in Haymarket at 6pm, which drops off after 8pm. There is an opportunity to support Haymarket's night time economy and re-establish the precinct as a late night destination.

Haymarket is part of Tech Central

The economic research found that Haymarket has a higher proportion of small and micro businesses than the wider CBD. Haymarket is part of Tech Central, a vibrant and growing innovation and technology precinct stretching to Camperdown (the biomed node) and Eveleigh (the deep tech node). Haymarket and its surrounding neighbourhoods are focused on digital and creative innovators. The City collaborates with universities, NSW Government, and sector partners to promote the growth of the innovation economy. For example the City supported Haymarket HQ's Sydney landing pad, a program which supports start ups from Asia to enter the Australian market. The City is also working towards the transformation of Broadway into a green avenue, which would strengthen the connection from Haymarket to the universities and the rest of Tech Central.

Haymarket's strengths

The economic study identified the following strengths and competitive advantages.

- highly connected to public transport
- being in the CBD with a large customer base
- proximity to the universities and a large student population

- near to the proposed Central Precinct western gateway development
- proximity to Darling Quarter, Darling Harbour, Capitol Theatre, Paddy's Markets
- urban feel and fine grain with distinct character
- Asian cultures reflected on street/public spaces
- authentic and affordable food offerings
- existing start-up incubator (Haymarket HQ)
- within the future Tech Central innovation precinct and proximity to established cluster of ICT and creative industries
- good pedestrian accessibility along/around George Street
- attractiveness to skilled migrants and international students
- engaged communities and emerging networks

Key opportunities

The economic study drew analysis of Chinatowns elsewhere to identify opportunities for Haymarket. This case study comparison highlighted interventions are most effective when they are wide in their breadth and they are led by grassroots community organisations, with Government playing a supporting role.

- enable community involvement and leadership
- leverage one of Sydney's most historically and culturally rich areas
- improve the public domain and ground plane (shop fronts)
- reposition the retail offer to meet demand
- strengthen and support existing anchors
- improve connectivity

Planning and development background

Chinatown in the Haymarket is not identified for high rise towers but it adjoins two tower cluster areas - one to the north and to the south.

Between these tower cluster areas, the distinctive character comes from its density of shopfronts with narrow frontages, small/irregular plots, and high level of small businesses and activities. The current planning controls in the Haymarket/Chinatown special character area aim to protect these characteristics, with lower building heights.

The economic study found that in this area, smaller scale and incremental development is desirable to help rejuvenate the area without detracting from the area's character. DCP controls could be reviewed to encourage small scale renewal which does not involve required amalgamation with neighbouring sites.

The west parts of Haymarket including Darling Square, north west Dixon Street, Market City and the Goods Line are state managed, sitting outside of the City's planning controls.

Central Precinct

A major development area is being planned to the south of Haymarket. A rezoning proposal aims to deliver a technology and innovation precinct by enabling development over and adjacent to the railway lines at Central Station.

Part of the precinct – the Western Gateway – has already been rezoned and is under construction.

These developments near Lee Street, including Atlassian's new global headquarters, will provide in total more than 300,000sqm of new office work space, bringing additional workers to the area. There is an opportunity for Haymarket to benefit from its close proximity to this growing tech precinct.

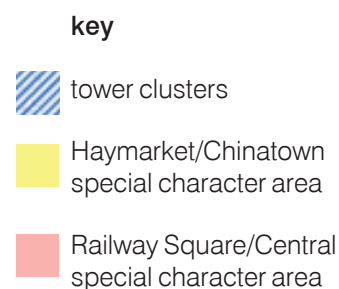
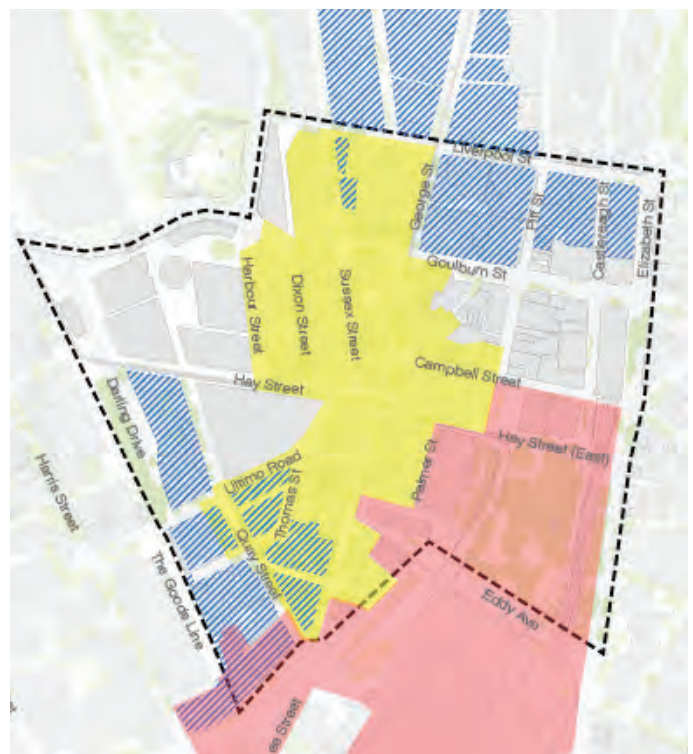
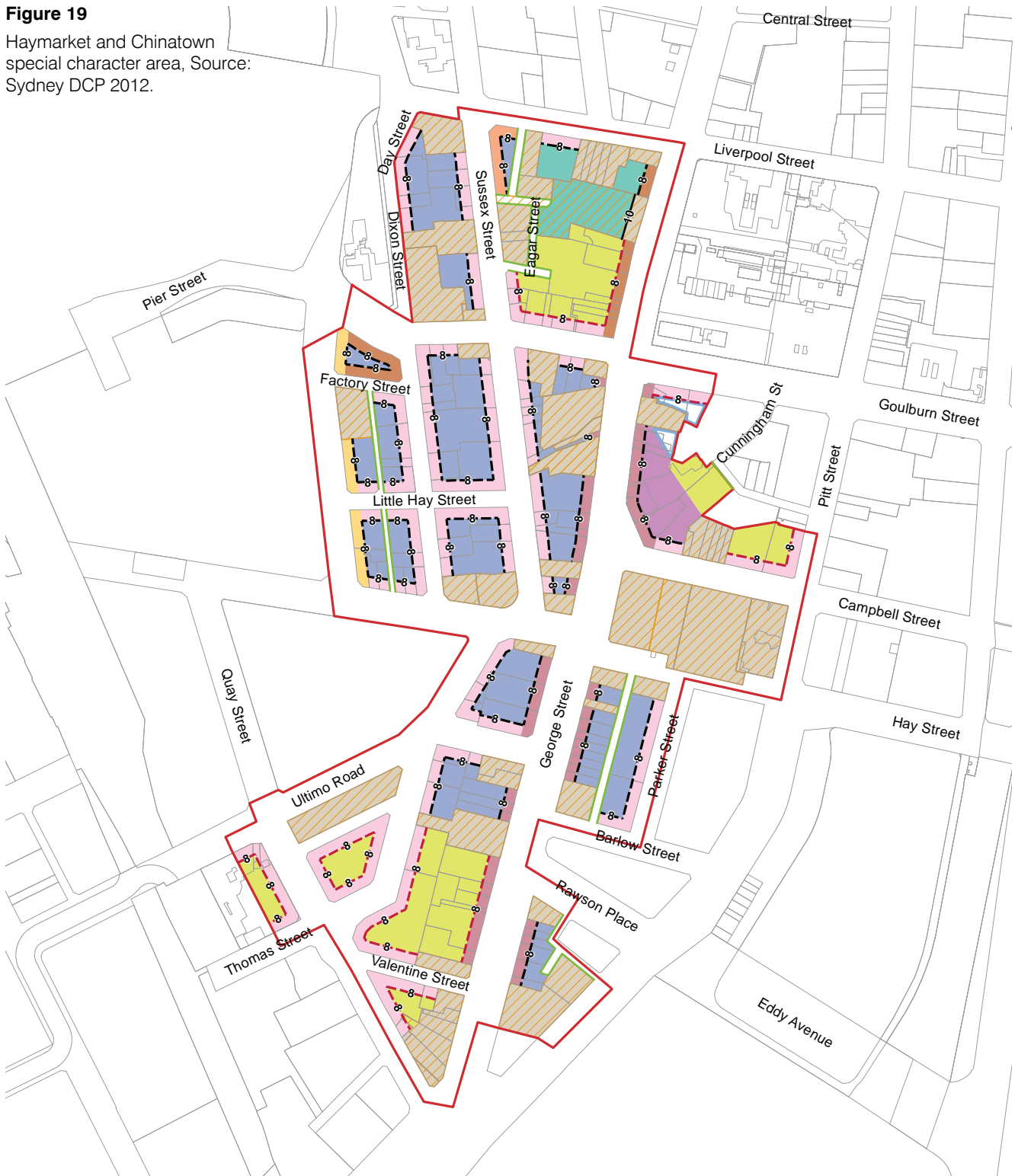

Figure 18
Key planning designations, Source: Sydney LEP 2012.

Figure 19

Haymarket and Chinatown special character area, Source: Sydney DCP 2012.



Haymarket / Chinatown Special Character Area

Figure 5.9

<ul style="list-style-type: none"> Special character area Heritage item Open space Laneway setback 10m setback above street frontage height of heritage item Front setback 	<ul style="list-style-type: none"> Setback above street frontage height (no variation) Setback above street frontage height (compensation system applies) <p>Street Frontage Height</p> <ul style="list-style-type: none"> Zero street frontage height (full setback) 	<ul style="list-style-type: none"> Existing height of building – see clause 5.1.3.1 (5) max 15m max 20m max 25m max 30m max 35m max 40m max 45m 	<p>Height Control</p> <ul style="list-style-type: none"> Site specific controls Existing height No specific SCA max height max 30m max 45m max 50m max 55m 	<ul style="list-style-type: none"> max 60m max 70m max 80m max 130m Area 1 Area 3
---	--	---	--	--

Heritage context

The surviving markets buildings, stores, warehouses and service laneways in Haymarket, along with the name of the area itself, is a reminder of its historic role as markets and its proximity to the former port of Darling Harbour.

The heritage buildings form a significant historic precinct of Victorian and Edwardian buildings of consistent character and scale, reflecting the period's growth and prosperity in relation to the markets and the railway terminus. This can be seen in those buildings at the intersections of George, Hay and Sussex Streets, including the Haymarket Chambers, Capitol Theatre, Palace Hotel, the Corporation Building, Bank of China building, Westpac Bank Building and former Burlington Hotel building.

The surviving former market buildings or building facades at the southern part of the area, including the Market City (housing Paddys Market) and UTS Business School at Quay Street demonstrate the cluster of the municipal markets built by the City of Sydney.

While there are many listed buildings in the area, few of the listings relate to the Chinese community and their long history in the area.

The Wing Sang & Co. building at 18-22 Campbell Street is culturally significant as the former headquarters for fruit merchants who supported many families' immigration from Guangdong, China. Today its ground floor is activated with Thai grocers and restaurants.



Figure 20

A drawing of Wing Sang & Co building at 20-22 Campbell Street Source: China-Australia Heritage Corridor



Figure 21
 A map of the listed heritage items, Source: Geocortex, Sydney LEP 2012

Recognising Chinese heritage in Haymarket

The City was aware that few of the heritage listings related to the Chinese community and their long history in the area. The City is working to address that gap.

The City recently listed 82-84 Dixon Street. The former Kwong War Chong & Company building is one of the earliest buildings and businesses that were built for, owned, and operated for over a century by people of Chinese descent in Chinatown. The cultural and community functions of the Kwong War Chong formed part of an extensive network of business, industrial and social relations among Chinese Australians in this period. Built in 1910, the building survives intact today, though the building is in need of conservation works.

The City has also commissioned a heritage assessment of the Chinatown Gates. Located on Dixon Street south, and constructed in 1970-80, the gates have historic significance for being a traditional Chinese ceremonial gateway that marks the entrance of Chinatown. The pair of gates were designed using traditional Chinese design and ornamentation. The Gates have social significance.

In addition, the City commissioned GML Heritage to undertake a Thematic History of Chinatown.

The study is not an extensive history of the history, but draws on other sources to provide a foundational understanding of the significance of Chinatown and the overarching historical themes.

It is intended that the Thematic History will guide future work in the area such as interpretation, placemaking, strategic planning and future heritage studies. The City will work with community members to gather further detail on the themes identified in the Thematic History, for instance through recording oral histories.

The Thematic History Study identified the following themes:

Theme 1: Evolving Chinatown

Chinatown as a destination, a place name and a unified urban area of Sydney evolved much later in the twentieth century. Concentrations of Chinese residences and businesses tell the story of evolving patterns of migration and a diversifying economy.

Theme 2: Living and working in Chinatown

The theme of living and working in Chinatown spans a vast range of historical experience. Formerly high-density neighbourhoods have vanished but new homes and businesses have taken their place. Discrimination against Chinese communities directly impacted on the function of business and their homes. However, the strength and diversity of Chinese people and businesses ensured a thriving network with international reach.

Theme 3: Belief, culture and community

Chinatown evolved over time from a place offering shelter and sanctuary to a hub of social, cultural, religious and political activity for Sydney's Chinese community and an international gateway for business.

Theme 4: Change and renewal in Chinatown

Like many Chinatowns globally, Sydney's Chinatown has been shaped by a range of factors. Development pressures, population decentralisation and shifting demographics have changed the fabric and boundaries of its communities. Consequently, the role of Chinatown has also evolved as it straddles its history and the new demands of our increasingly globalised world.

Figure 22

Clockwise from top left: King Fong's family grocery store Say Tin Fong, 52 Dixon Street, 1954. (Source: China–Australia Heritage Corridor); Dixon Street 1986 (Source: National Archives of Australia); Wing San & Co Sussex Street 1909–1913 (Source: City of Sydney archive); children in a Harbour Street shop (Source: China–Australia Heritage Corridor); Pageant of Nations Town Hall (Source: State Library of NSW)



Haymarket's streets

Haymarket's streets have changed significantly since the City developed its first Chinatown Public Domain Plan in 2010.

The CBD and South East Light Rail has been realised, including several streetscape upgrades. George Street has been transformed into a green, pedestrian boulevard that now unites the precinct east to west.

Similarly, the Haymarket section of Hay Street is a pedestrian street and light rail route which has recently been upgraded with wider footpaths and new street furniture.

Darling Square has created a new green space for Haymarket, as well as a network of laneways and space for outdoor dining. It has also improved the walking connection north to Darling Harbour.

Many of the other streets - Ultimo Road and Thomas Street for example - have been upgraded as local streets, where traffic is slowed and more space is given over to pedestrians.

The street network is evolving to prioritise people walking, cycling and taking public transport. The network must also enable deliveries and services to keep the fine grain ground floor retail alive. Vehicular through traffic is now focused on Goulburn Street, Darling Drive and Pitt Street. These changes mean that while Haymarket is still accessible by car for those who need it, the routes may be different and may take longer.

The community feedback acknowledged this tension and transition. Many people were positive about the changes George Street and wanted to see more improvements for pedestrians in Haymarket. Others felt that it has become more difficult to park in Haymarket which may discourage people from visiting the precinct.



Figure 23

Images of Haymarket: (top) George Street becomes a pedestrian boulevard (bottom) Upgrades and public art on Thomas Street. Source: City of Sydney

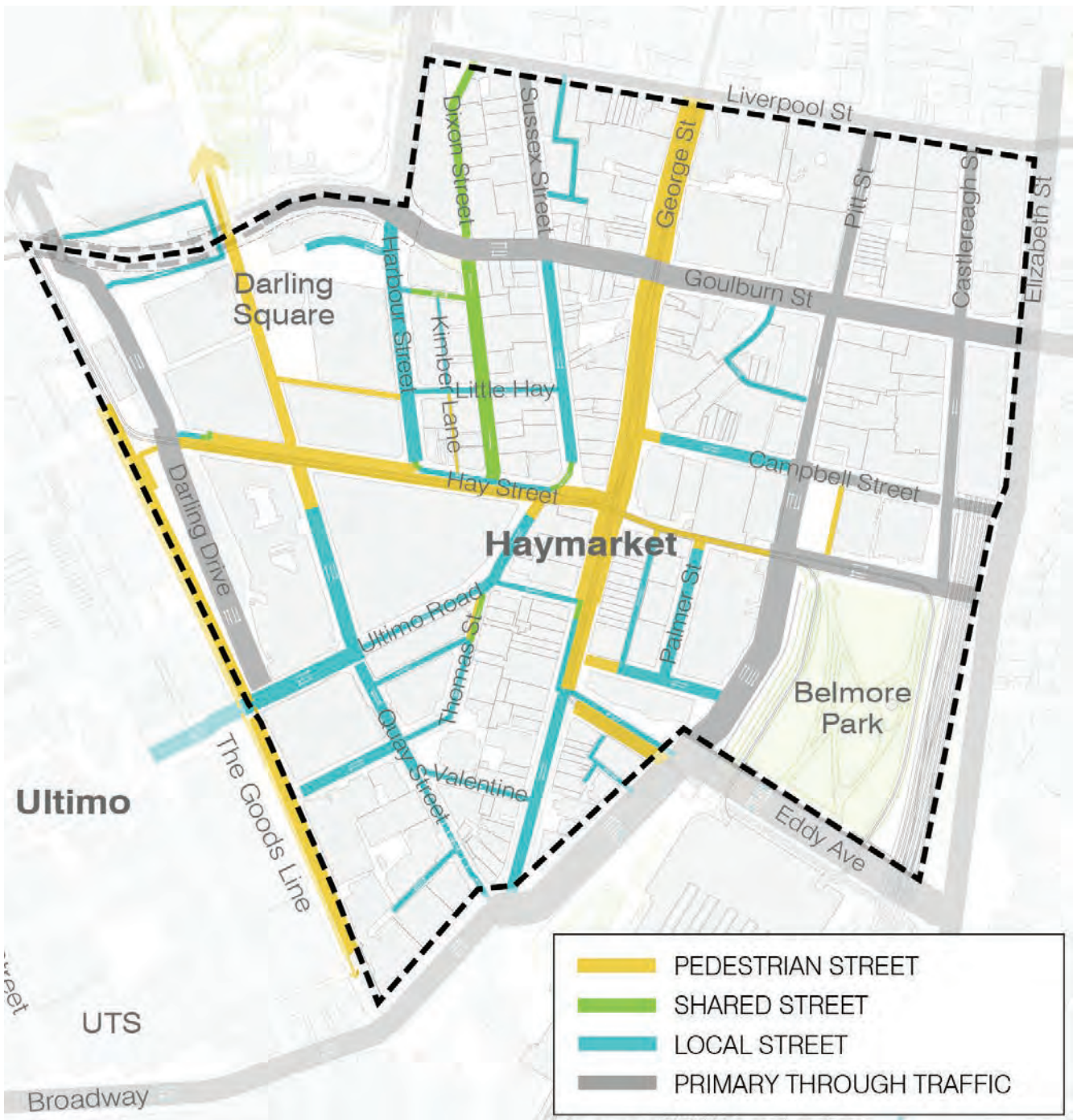

Figure 24
 A map of Haymarket's street network. Source: City of Sydney

Existing events and culture

Cultural and community events play a significant role in animating the precinct and supporting local economies. When led by local people and organisations, these events can have long-term positive impacts on community and business development. The City supports a wide range of community-led initiatives through its grants program.

The Chinatown Markets on Friday evenings in Dixon Street south offer Asian-inspired food, design and art, and are an important part of the regular rhythms of the precinct.

Street festivals, including the annual Sydney Lunar Festival, Vivid Sydney and bi-annual Sydney Streets, invite people onto the street for parades, performers, music, and food.

Neon Playground was a highly successful festival in 2022 funded through the City's grants program and organised by Haymarket HQ, Haymarket Chamber of Commerce, Soul of Chinatown, Basalt Studio and Bespok3.

Cultural and community organisations - including the Chinese Garden of Friendship, 4A Centre for Contemporary Asian Art, Tumbalong Park, Darling Square Library and Capitol Theatre - are key draw-cards for the area and have a changing program.

The City-supported Museum of Chinese in Australia (MOCA) is due to open in 2023/24 in the former Haymarket library building.

Figure 25

A year of events in Haymarket . Source: City of Sydney.



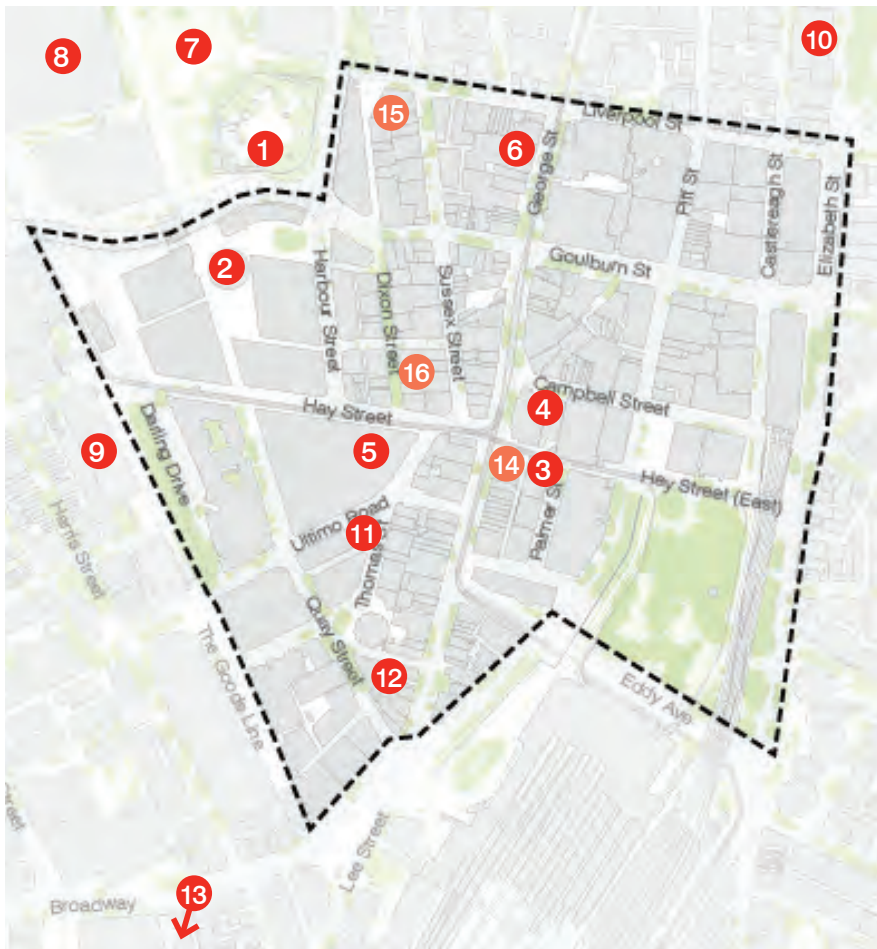

Key cultural and community institutions:

- 1 Chinese Garden of Friendship
- 2 Darling Square Library
- 3 4A Centre for Contemporary Asian Art
- 4 Capitol Theatre
- 5 Paddy's Market
- 6 Event Cinemas
- 7 Tumbalong Park
- 8 ICCC
- 9 Powerhouse Museum
- 10 Korean Cultural Centre
- 11 Passage Gallery
- 12 Blank Gallery
- 13 White Rabbit Gallery

Future / potential:

- 14 MOCA
- 15 former Harbour City Cinema
- 16 former Kwong War Chong building

Figure 26

Key cultural and community spaces, Source: City of Sydney

May-June

Vivid

Central & The Goods Line

A three-week festival of installations, light projections, and music events

August

Thailand Grand Festival

Two-day festival with drum procession, Thai markets, cultural performances, kids activities, massage, cooking and games

October

SXSW Sydney

Haymarket

A week of tech, games, innovation, music, screen and culture



June

Sydney Streets

Core Chinatown Area

Transforming village high streets into spaces for walking, shopping, and dining

September

Sydney Streets

Core Chinatown Area

Community vision

A community vision and themes for Haymarket have been informed by extensive consultation.

The community vision for Haymarket is summarised as:

“A vibrant, bustling place that celebrates diverse Asian cultures, that preserves its history and character while embracing contemporary forms of cultural expression”



Respectful of history and celebrates culture

Haymarket has a rich history. It is to be a place where diverse traditions and cultures inform the character of the area.

- recognise Chinatown’s history and heritage
- revitalise Dixon Street as the heart of Chinatown
- encourage expression of Asian cultures throughout the precinct
- support storytelling, sharing of memories, traditions and living cultures
- more public art by Chinese/Australian artists



Global, diverse and evolving

Haymarket is to be globally connected, lively throughout the day and night, and constantly evolving.

- encourage people to visit and spend time in Haymarket through diverse food and retail
- recognise the precinct’s relationship to global Asia
- support 24-hour activation and a thriving night-time economy of bars, stalls and music
- allow the character to be different to elsewhere in the CBD
- increase embellishment and creative lighting



Accessible and connected

Haymarket is easy to get to and get around within. Places within the precinct are connected and people of all ages find it accessible.

- make it easy to travel to the precinct as a key destination from across Greater Sydney
- strengthen connections within Haymarket, linking different experiences
- improve pedestrian and cycle access
- support multigenerational and universal access



Green, clean and welcoming

Haymarket is to be clean, green, safe and welcoming to the community. It is more comfortable, with a good balance of light, shade and amenity. The streets and public spaces are well-designed and maintained by Council, residents and local businesses.

- increase regular cleaning and maintenance
- increase pruning and greenery through delivering the urban forest strategy
- make attractive and welcoming public spaces for everyone to enjoy
- ensure a safe and inclusive precinct



Authentic, affordable and local

Haymarket serves and reflects its local communities. It has a range of offers, places and spaces that are unique to the area, support everyday life. Visitors are attracted to its unique character.

- support independent local businesses
- continue to make food and drink the focus
- increase street life with better lighting
- expand the offer with experiential and unique/ specialty retail to appeal to the growing younger Asian cohort



Through partnerships and in collaboration

Haymarket's revitalisation is led by people who are passionate about its future. Its identity is shaped by its communities. Haymarket thrives through partnerships, a willingness to collaborate and leadership.

- support and encourage community-led initiatives
- work with local people, organisations, businesses, and landowners
- remove barriers and red tape to work with the City

The City's approach

The City is committed to realising the community's vision for Haymarket. We recognise that there is no silver bullet; a wide-ranging set of actions is needed to catalyse to positive change in the area.

This section of the document sets out a five-point plan with actions to explore in each area. We would like to hear your views on this approach and which actions you would like the City to prioritise.

While the City needs to do our part, we are just one of the many stakeholders in the area. Local people, businesses, landowners and the NSW Government play an important role in shaping the revitalisation of the Haymarket. We need to enable and work together with others to realise the community's vision for Haymarket.

In our conversations, we've met lots of passionate people and businesses who are doing their part in making this vision a reality.

There are some actions which the City can lead on, like transforming the streets and spaces which we own. Where we do not have ownership or oversight, it will be more challenging. We can support others, for example through grant funding or advocating for the change we would like to see.

Collaboration and partnerships will be critical in delivering the revitalisation of Haymarket.



Figure 27

Images of Haymarket: (top) Try a bike at Darling Square, (middle and bottom) Sydney Lunar Streets 2023. Source: City of Sydney



Figure 28

The City's five-point plan to support the revitalisation of Haymarket. Source: City of Sydney

1. Renewal of the heart

The economic research reveals that Dixon Street has the highest proportion of ground floor vacancies and the lowest activity levels.

We heard from you that Dixon Street is special as the heart of Chinatown and that it is a top priority for improvement.

Investment is needed to ensure that the Dixon Street 'heart' is distinctive and draws on its rich history, heritage and Cantonese roots to create a inviting and welcoming experience.

A substantial investment in the public domain and lighting will be made but needs to be accompanied by a transformation of the public facing run down building appearance with shopfronts/activity that enhances their character and has market appeal.

The public domain upgrades will help to refresh the street, with new paving inserts, lighting, planting, tree pruning and street furniture.

These interventions will enhance the quality of the place and provide the flexible infrastructure to support the area's vibrant cultural life. The ceremonial gates will be repaired and restored.

Drawing on its strengths, Dixon Street could be reinvented as a chef's gallery, bringing the theatre of cooking and food preparation to the street, as well as substantial increase in outdoor dining.

Incentives are needed to motivate landowners to improve their buildings, bringing vacant space back into use and breathing new life into the street. This would be similar to a main street program at a smaller scale.

Financial incentives available for a limited period of time have the potential to kick start private investment in the area and catalyse on-going renewal.

Actions to explore

- main street improvement program for Dixon Street south (the heart) to incentivise facade, awning and food and beverage shopfront improvements via a DA process. Improvements to be eligible for a co-funding program for a limited period of time (three years)
- food and beverage shopfront improvements could bring food preparation to the window as a form of theatre and for street interest
- introduce a design guide and planning concierge service for private buildings: facade, awning and shopfront upgrades for Dixon Street

Actions already underway

- design work is underway for the upgrade of Dixon Street's public domain – paving, lighting, planting, street furniture
- planned restoration of the Chinatown ceremonial gates
- business sector support grants to grow the skills of local businesses, provide networking opportunities and promote the local precinct



Figure 29

A photo of Dixon Street shopfronts in need of upgrading.
Source: City of Sydney



Figure 30

An image of a chef cooking in Haymarket viewed through the restaurant's window. Source: City of Sydney

Potential action: Co-funding incentive

Dixon Street is in great need of improvement - both in term of the building and shopfront presentation and the offer. The buildings are privately owned by many different landowners, and it seems that market forces alone are not stimulating renewal or upgrading.

Incentives are needed to motivate landowners to improve their buildings, bringing vacant space back into use and breath new life into the street. Limited time financial incentives have the potential to kick start private investment in the area and catalyse on-going renewal.

The City proposes to develop a co-funding incentive or grant program for Dixon Street south. Co-funding of capital improvements could include:

- works to the shopfronts to engage with public domain and re-present the ground-floor business
- works to bring food preparation to the shopfront, perhaps creating a 'chefs gallery' on Dixon Street
- improvements and repairs to the heritage awnings
- improvements to the upper storey facades (above the awnings), such as cleaning, repairs and repainting

A co-funding scheme would require matched funding from the landowner and engagement with the business operator at ground.

To be eligible, landowners would need to lodge a DA with the assistance of planning who would offer support navigating the planning process.

A maximum amount of funding available would be set per applicant and overall. The grant would be available for a set period of time (three years).

Action considerations

City leads grants + city planning

Stakeholders and partners landowners, businesses, and design and heritage professionals

Timeframe medium term for a fixed three year term

Additional budget yes - to commission a design guide and provide the grant



Figure 31
 Photos of three shopfronts in Haymarket which bring food preparation to the front window. Source: City of Sydney

2. Planning and heritage

The City's planning framework is a key tool for encouraging landowner investment in buildings and to provide the type of space for the activities you said you want to see. Haymarket's distinct character can be enhanced and cultivated through the rules and guidance we set. The City's approach to land use planning can positively contribute to the evolution and revitalisation of Chinatown and Haymarket.

The character of the area is distinct from the rest of Central Sydney. Instead of large corporate towers, the area's human scaled shopfronts, low to midrise buildings and small irregular plots and diversity of business make for active and vibrant streets. The controls within the special character look to protect these attributes. Community feedback indicates that people value this unique character and would like to see it preserved.

The economic research suggests that small scale development and renewal should be encouraged, to refresh the area while also retaining the area's distinct character. One way to promote this further may be through raising the street wall height, allowing small plots to redevelop individually and achieve their full potential under the LEP, without the need for amalgamation with neighbours.

In terms of land use, we know that the area's identity is and will continue to be rooted in cuisine both in restaurants and fresh food grocers. In addition to this, the economic work identified the need for more 'anchors', attracting people to the area. More entertainment, cultural and community venues, as well as unique and specialty retail will be needed to add to the area's offer.

We heard from you that the character of the signage, art and lighting in Haymarket should be different from the rest of Central Sydney and that you would like it to become even more vibrant, with contemporary expressions of Asian cultures. We propose to review our planning rules, to allow for more individuality and expression.

The planning framework also protects the area's built heritage. The area is designated a 'special character area' and home to many heritage listed buildings, however few of these listings currently acknowledge the significance of the area to the Chinese community. Further work will be done to strengthen our approach to heritage to better recognise Chinese history in the area.

Actions to explore

- allowing more freedom and cultural expression in signage controls and lighting to enhance the night time economy
- encourage fine grain with renewal by lifting the street wall height in the special character area in order to make upgrades and renewal more feasible
- advocate for the transformation of the interior and exterior of Paddy's markets and offer focused on East Asian food and produce
- strengthen heritage narrative: update locality statements, statements of significance, and identify new items for listing to recognise Chinese history
- advocate for the conservation and reuse of the former Kwong War Chong building at 82-84 Dixon Street

Actions already underway

- heritage list the Chinatown Gates
- already designated a special character area
- Kwong War Chong building at 82-84 Dixon Street was heritage listed in 2020
- the Central Sydney Planning Framework designates tower clusters either side of Chinatown to support employment growth without changing essential character
- fees waived for outdoor dining until 2025



Figure 32

An photo of Hay Street with a market on. Source: City of Sydney

Action: Encourage fine grain renewal

The character of the area is distinct from the rest of Central Sydney. Instead of large corporate towers with sterilised frontages, the area's narrow shopfronts, low to midrise buildings and small irregular plots make for active and vibrant streets. For example, on George Street the widths of building frontages are on average 8m wide in Chinatown compared to 15m or more in the northern part of the CBD.

These smaller shopfronts are more suitable for independent businesses, rather than chainstores. Community feedback indicates that people value this character and would like to see it maintained.

The economic study recommends that small scale development and renewal is encouraged, to refresh the area while also retaining the area's distinct character.

Currently the planning controls require a streetwall height of 15m with an 8m set back. For small and irregular shaped sites, this results in a significant loss of floorspace and in small floorplates which are often unviable for commercial uses. Development therefore is not possible without amalgamation, which would result in the loss of the historic ownership pattern and fine grain character of the area.

In order to allow smaller sites to redevelop individually, the City proposes to reconsider the street wall heights and setbacks in the special character area (except for Dixon Street).

The City has tested raising the street wall height from 15m (the current planning controls) to 35m (option 1) and to the full height of 45m (option 2), considering what impact this has on sunlight and views of the sky. Benchmark testing against other CBD streets demonstrates that there is capacity to increase the street wall height without detrimental effects to the sunlight in the public domain.

Action considerations

City lead	strategic planning and urban design + planning assessments
------------------	--

Stakeholders and partners	landowners, design and heritage professionals
----------------------------------	---

Timeframe	short term, 0-12 months
------------------	-------------------------

Additional budget	no - within existing budget
--------------------------	-----------------------------

Existing planning rules - 15m street wall height:

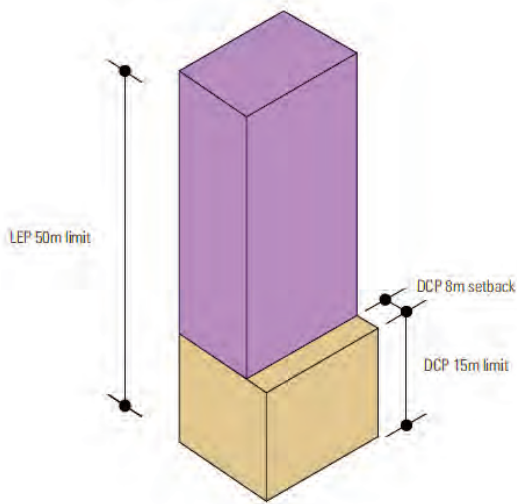

Option 1 - raise street wall height to 35m: (preferred)

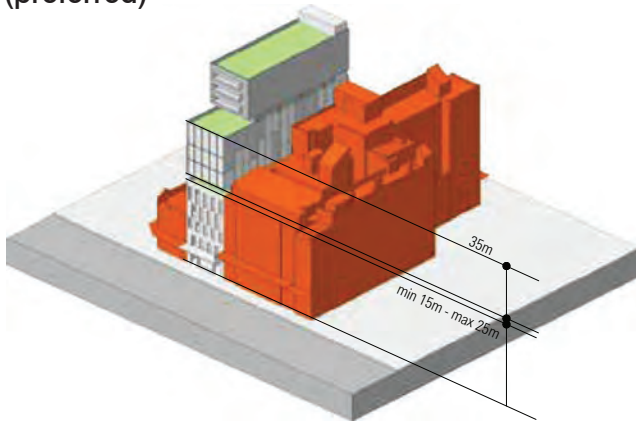

Option 2 - raise street wall height to 45m:

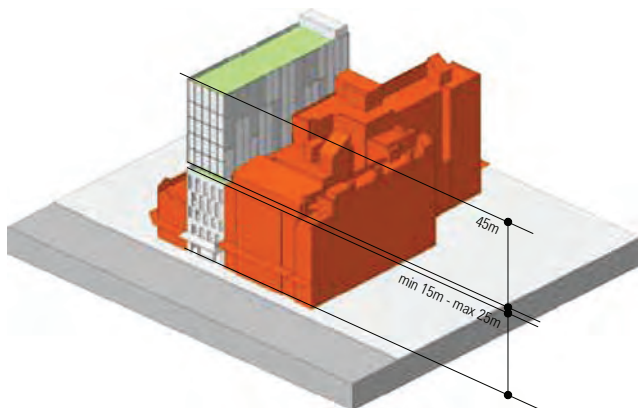

Figure 33

A series of three diagrams, showing the existing planning controls, option 1 raising the street wall height to 35m and option 2 raising the street wall height to 45m.



Figure 34

A plan showing that very few sites (shown in yellow) in the special character area are able to be redeveloped to their full potential without amalgamating with their neighbours.

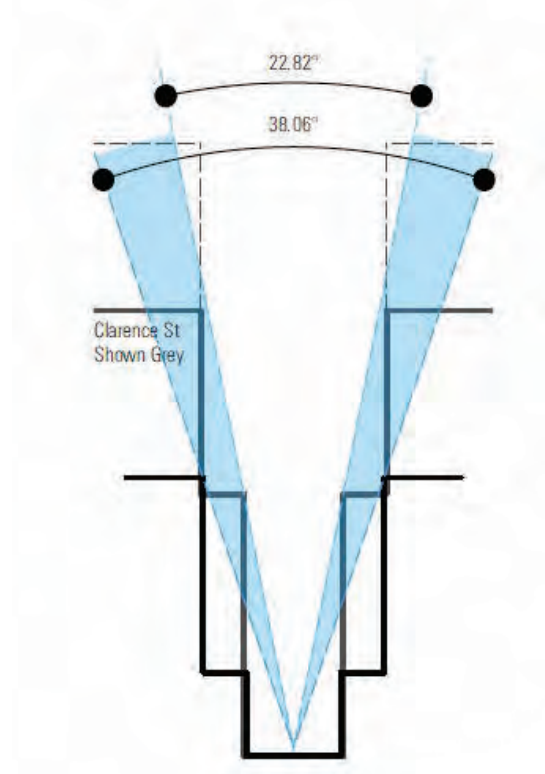

Figure 35

A street section showing benchmark testing of Sussex Street (shown in black) against Clarence Street (shown in grey), demonstrating that there is capacity to increase the street wall height without bringing detrimental impacts to the daylight in the public domain.

Action: Encourage cultural expression in building signage and lighting

Chinatowns globally have a strong association with larger expressive signage on buildings and neon. Lighting has a crucial role to play in attracting people at night and supporting the night time economy.

The City has planning rules in the Development Control Plan (DCP) from the special character area which limit the type, size, positioning and number of signs on a building.

We heard through engagement that the community would like to see vibrant creative lighting and contemporary cultural expression in Haymarket.

This can be delivered in part through the City's approach to the public domain and art.

It can also be delivered through planning rules for the Haymarket to encourage cultural expression in signage and lighting. Within a yet to be defined 'signage precinct', signs on buildings would be allowed to be larger and more frequent, if they are of a high quality and in keeping with the area's character.

For example, additional signs beyond the current controls may be permitted if they are neon or LED neon-like with artistic and cultural expression.

Action considerations

City lead strategic planning and urban design + planning assessments

Stakeholders and partners landowners, design and heritage professionals

Timeframe short term, 0-12 months

Additional budget no - within existing budget

Figure 36 (opposite page)

Photos of neon signage. Clockwise from top left: Kowloon cafe in Eastwood, Source: Yusuke Oba; Singapore Chinatown signage, Source: www.easternneon.com.sg; Hong Kong signage, Source: arcaid; San Francisco Chinatown signage; and Tate Britain 'remembering a brave new world' exhibition Source: Dezeen



Action: Strengthen cultural heritage

While the area is designated as a special character area and includes many listed buildings, very few listings relate to the Chinese community and their long history in the area.

The City of Sydney commissioned GML Heritage to undertake a Thematic History of Chinatown. The Thematic History is a broad, foundational study to guide understanding of the significance of Chinatown and the overarching historical themes.

Based on this work, the City is reviewing and updating the locality statement for the Haymarket and Chinatown special character area to acknowledge the social and cultural significance of the area to the Chinese and Asian community.

The City is also updating the inventory sheets for five listed buildings to include Chinese history and significance.

There are three additional unlisted buildings that were identified through the research and engagement as potentially having cultural significance, particularly historic and social value linked to the Chinese community:

- 75-77 Ultimo Road, Kuomintang Building
- 50-54 Dixon Street, Tu Wang Times Headquarters
- 90-100 Hay Street

The City proposes to carry out further investigation of these three buildings to better understand their significance and whether they should be listed. If listed and conserved, they could be eligible for an award of heritage floorspace.

This will involve a further heritage study. If the buildings were to be recommended for listing, a planning proposal would be needed to amend the Local Environmental Plan (SLEP 2012).

Action considerations

City lead strategic planning and urban design

Stakeholders and partners landowners, design and heritage professionals, the Department for Planning and Environment

Timeframe medium term, 1-2 years

Additional budget no - within existing budget

Figure 37

Photos of buildings identified for further investigation. Top left - 75-77 Ultimo Road. Top right - 50-54 Hay Street. Bottom - 90-100 Hay Street. Source: City of Sydney.



3. Public domain and art

Work to revitalise Haymarket has already begun. George Street South has been recently transformed into a pedestrian boulevard.

Changes to Hay Street, Ultimo Road and Thomas Street have created new opportunities for footpath widening, tree planting and events. Designs are being prepared to improve Dixon Street, including restoration of the Chinatown Gates.

You told us that the streets and public spaces are important in Haymarket. The area is known for having a busy street life and being a place where you see diverse cultures reflected on the streets and in public spaces. You wanted to see more creative lighting, pedestrian-friendly streets, outdoor dining, public amenities like seating and public toilets, and better cleaning and maintenance.

You wanted the streetscape to respect the heritage and character of the area, while bringing colour and celebrating diverse Asian cultures.

The Haymarket street network needs to acknowledge different needs from greening and active transport, to footpath widening in some locations to catering for fine grain retail deliveries and servicing to pick up/drop off and short term parking on the street.

The Haymarket can be transformed into a precinct of gardens, light and colour. The public space should reflect its diverse Asian communities, be respectful of history, and provides a platform for everyday street life and cultural celebration. Community feedback suggested social moments for young and old, such as places for mahjong and other games.

The Haymarket Public Domain Plan is being produced for the precinct as a whole, to improve streets, squares and open spaces, and to provide new public art. Feedback from the community will be sought to prioritise the opportunities and plan the City's future capital works.

Potential actions

- creative lighting as a point of difference and to establish the precinct as a place to visit at night
- draw people into the core Chinatown area with improved amenity and creative lighting
- more spaces and infrastructure for cultural events
- more trees and greening in the precinct
- upgrade Campbell Street as the heart of Thai Town
- upgrade Belmore Park with safe lighting and improve connections to the future Central Square
- support the fine grain street retail with adequate daily delivery and freight space and short-term parking
- consider 15 minute free drop off and pick up spaces (short stay parking) in the precinct
- new opportunities for public art
- consider options for cycling connections

Actions already underway

- recent public domain upgrades have been made to George Street South, Hay Street and Ultimo Road
- design work is underway to upgrade Dixon Street
- restoration of the Chinatown Gates is being progressed



Figure 38
Two artist's impressions of what Haymarket's streets could look like with improvements proposed in the Draft Haymarket Public Domain Plan: (top) Hay Street (bottom) Campbell Street.

4. Culture, events and activation

A changing calendar of events and activities can provide a compelling reason for people to visit the area to enjoy busy and creative street life.

The economic research found that the Neon Playground event, community devised and funded by the City's precinct activation grants, significantly increased visitor numbers.

Events also provide opportunities for the expression of Asian cultures and celebration of the area's history. The economic research identified 'leveraging one of Sydney's most historically and culturally rich areas' as a key opportunity.

There is potential for Haymarket to be brought to life by celebration, events and gathering.

Embracing the wider remit of cultural celebrations of East Asian origin will provide a point of difference from other precincts and places. The public domain plan will ensure it has many social places at a variety of sizes that provide flexible infrastructure for creative lighting, public art, parades, markets and performance.

Much is already being done by the cultural and community organisations in the area including the Chinese Garden of Friendship, 4A Centre for Contemporary Asian Art, Tumbalong Park, Darling Square Library and Capitol Theatre. Through collaboration with these partners, the City will seek to support and explore any opportunities to expand their program.

You told us that you value the area's social and cultural history and would like to hear those stories told.

The City-supported Museum of Chinese in Australia (MOCA) is due to open in 2023/24 in the former Haymarket library building, helping to tell these stories. The City also proposes to identify opportunities for showcasing its archives and research of Haymarket's history, for example, through walking tours, hoardings, and plaques.

Potential actions

- support additional festivals and events which celebrate Asian cultures and activate the precinct with \$200,000 additional grant funding
- build on the City of Sydney's oral history collection, which includes approximately 20 interviews with members of the Chinese community from the 1990s to now. Identify up to five potential oral history candidates who could talk about the evolution of Chinatown in the last 50 years
- identify opportunities for additional historic interpretation, for example, City Walks tours, hoardings and plaques
- explore opportunities to secure long-term legacy and place benefits of SXSW Sydney
- review the 2022 Floor Space and Employment Survey data to identify opportunities to utilise vacant upper level floorspace

Actions already underway

- Haymarket has been awarded \$200,000 as part of the Uptown Grant Program to develop a destination brand, marketing assets and campaign to raise awareness about what the precinct has to offer to help generate increased foot traffic. This City will work with the group to support and amplify their efforts for the area
- annual production of Sydney Lunar New Year
- support for Friday night markets
- grant funding for festivals and events
- Sydney Streets events close down local streets twice annually in the Haymarket area. Local business trade out, with street performers to attract visitation
- an accommodation grant to support the creation of the new Museum of Chinese in Australia (MOCA), due to open in 2023/24

Figure 39

A photo of Harbour Street during the 2022 Sydney Lunar New Year event. Source: City of Sydney.



Action: Support additional festivals, events and activations

There is potential for Haymarket to be brought to life by celebration, events, and gathering for different cultures.

Focusing these on the cultural celebrations of Asian communities will provide a point of difference from other precincts.

The community told us that they would like to have more events, festivals, markets, and cultural activities. Having these organised by local people and organisations allows for them to make the greatest impact.

In November 2022, Soul of Chinatown, Haymarket Chamber of Commerce and Haymarket HQ worked together to organise Neon Playground. The event was supported by the City's Precinct Activation Grant. The 4-week festival resulted in a surge of activity, increased trade for local businesses, and stronger relationships between local stakeholders.

The City's existing grant program supports festivals and events that celebrate, develop and engage our communities. The City proposes to extend its grant program through increased funding for a limited period (three years) to enable additional community-led festivals and events which activate the precinct.

action considerations

City lead

grants team

Stakeholders and partners

community groups and cultural organisations

Timeframe

medium term, 1-3 years

Additional budget

yes - additional grant funding

Figure 40

A photo of Lunar Streets part of the Lunar New Year celebrations in 2014 on Campbell Street in Thai Town. Source: City of Sydney.



Action: Celebrating the social and cultural history of Haymarket

You told us that you value the area's social and cultural history and would like to hear those stories told. The grant-funded Museum of Chinese in Australia (MOCA) is due to open in 2023/24 in the former Haymarket library building, helping to tell these stories.

Within MOCA, there may also be rooms or meeting spaces or event support space for different community groups.

The City proposes to identify further opportunities for showcasing its archives and research of Haymarket's history. This could include:

- further develop a walking tour in Haymarket. The City has created an existing walking tour that covers Haymarket and Chinatown which is available as an accessible PDF and via the Sydney Culture Walks app. This walk could be reviewed and updated to highlight further significant places and the stories of their past. Audio snippets, drawn from the City's oral history collection, could be included in the app. It could also have physical elements (such as inscribed pavers or plaques) in the streets and spaces
- identifying opportunities for historical interpretation (such as plaques), acknowledging significant places for Chinese people and community across Haymarket
- using construction hoardings to display historic images that are relevant to the area

Action considerations

City lead city historian, city planning, city design

Stakeholders and partners MOCA, history and heritage professionals and community groups

Timeframe medium term, 1-3 years

Additional budget no - within existing budget

Figure 41 (opposite page)

A photo of former Haymarket Library building on George Street which is becoming the Museum of Chinese in Australia (MOCA) with grant support from the City. Source: www.moca.com.au



Action: Secure legacy and place benefits of SXSW Sydney

SXSW Sydney is a week-long event where tech and innovation, games, music and screen industries converge with culture for unexpected discoveries. It offers talks, music festivals, showcases, expos, red carpet premieres and networking with the world's best thinkers. It is the Asia-Pacific iteration of one of the world's most successful tech events and will be based in Sydney for a minimum of five years.

In its first year in October 2023, more than 1,000 sessions, events and activities are proposed to take place in streets, public spaces, and venues across Haymarket and Darling Harbour. The City is supporting the 2023 event with funding and value in kind.

SXSW Sydney aims to:

- provide a platform for the Asia Pacific's creator industries to gain exposure and increase business connections
- pandemic recovery and economic activity - maximise visitation, room nights, collaboration
- cement Sydney and Australia's position as a creator industries powerhouse
- invigorate Sydney's 24 Hour Economy and change the global narrative
- educate Government, the media and the general population about the economic benefits of the cultural and creator industries
- attract sustainable offshore investment into the local creator industries, creating jobs and developing local talent
- support women, indigenous and diverse communities in tech, music, gaming and screen

Action considerations

City lead

city business, grants + economic strategy

Stakeholders and partners

SXSW, tech and creative sector business, NSW Government

Timeframe

medium term, 1-4 years

Additional budget

yes - additional funding is needed for support of SXSW in subsequent years

SXSW Sydney presents a major opportunity to promote the growth of Haymarket's tech and creative industries, profile local entrepreneurs, celebrate and explore Australian and Asian cultures, and drive footfall to local businesses.

While organisation for the 2023 event is underway, there is a need to think beyond the first year to consider the potential longer term benefits. Following the first pilot year, the City could consider on-going support of the event to secure these benefits for Haymarket.



Figure 42

A photo of Neon Playground festival organised collaboratively by local organisations and funded by the City's precinct activation grants. Source: City of Sydney.

5. Collaboration and partnerships

Community led revitalisation is not a new concept in Haymarket. In the 1970s the Dixon Street Beautification Committee was formed to consider the creation of a 'Chinese centre' in Sydney. The committee made recommendations for beautifying Dixon Street in a Chinese style and lobbied business owners to bear the cost of improving the building facades, shop signs and Chinese decorative banners.

The City of Sydney worked with the committee to trial the closure of the street for six-months before closing it permanently. After a successful trial, the new streetscape and ceremonial gates were constructed, costing the Council \$300,000 with the Chinese community contributing a further \$70,000. On 15 October 1980, the pedestrianised Dixon Street was opened. It remains valued as the heart of Chinatown to this day.

Through engagement, we heard that community representatives act as cultural custodians, with a great sense of responsibility for the future of Haymarket. They expressed a desire to work together with the City of Sydney. We met many local champions and groups who are already contributing to the revitalisation of the area.

Similarly, the economic study's international case study comparison found that interventions are most effective and authentic when they are led by grassroots community organisations, with local government playing a supporting role.

We want to ensure that the local communities, businesses, and landowners in Haymarket are empowered. Change should be led by local champions and through coordinated community initiatives. Grant funding will go some way to supporting local groups. New governance structures or organisations may be needed to allow for more effective collaboration. We also need to make sure that our processes are easy to navigate and accessible to all.

NSW Government will also play an important role

in shaping the future of Haymarket. The Darling Harbour part of Haymarket sits outside the City's jurisdiction and some of the streets, spaces and buildings are owned by the State – notably Darling Quarter, the north part of Dixon Street and the Market City/Paddy's Market building. There are also State programs and grants that can assist. The City will encourage the NSW Government to use its assets, planning and programs towards the delivering on joined up community's vision for Haymarket.

Potential actions

- fund a new Haymarket coordinator to channel the various actions and provide a 'concierge service' for community members, businesses and landowners who want to be involved
- set up an informal Haymarket Forum of existing chambers, groups and champions to coordinate projects for the revitalisation of Haymarket
- advocate for integration and activation of NSW Government assets, including Market City, Dixon Street north and Quay Street
- consider participation in state's Purple Flag safety accreditation program to encourage areas to meet standards for vibrancy, diversity and safety at night

Actions already underway

- existing grant funding program
- regular collaboration with Chambers of Commerce and local community groups
- community working group to support the organisation of Sydney Lunar New Year
- recent Haymarket visioning engagement
- collaboration to support Tech Central, including work with Haymarket HQ, UTS, NSW Government and the local business chambers

Figure 43

A photo of Neon Playground festival organised collaboratively by local organisations and funded by the City's precinct activation grants. Source: City of Sydney.



Action: Haymarket coordinator

The themes and actions in this plan are complex, overlapping and involve many different teams from the City. We heard through engagement that our processes (such as development or grant applications) can be challenging to navigate, especially when there are language or cultural barriers.

Having a dedicated person to provide a 'concierge service' would help make it easier for community members, landowners and local businesses to get involved.

The City will fund a Haymarket coordinator position for a fixed term (3 years) to coordinate the different streams of work and be a point of contact for the community. This position's role could include:

- supporting business and landowners as they navigate the planning system
- reaching out to local business and providing information about the support available to them
- raise awareness of the grants program and provide advice and guidance to potential applicants
- supporting community groups, cultural organisations and others who may want to organise events or activations in the public domain
- carrying out a survey of local operators to understand barriers to late night trading. Encouraging and supporting operators to extend their trading hours later into the evening
- providing information about the Dixon Street south co-funding program (see page 46)
- assisting with the potential Haymarket Forum being an advisory group and champions for change (see page 70)

Action considerations

City lead

city planning + city business

Stakeholders and partners

community groups and cultural organisations

Timeframe

short term, 0-12 months
ongoing for 3 years

Additional budget

yes - additional funding for a new full time position

Figure 44 (opposite page)

A photo of Belmore Park in autumn. Source: City of Sydney.



Action: Haymarket Forum

In the preparation of this Strategy, the City has met with many individuals and groups who are doing amazing work to revitalise Haymarket. Community groups, chambers, local businesses, landowners, residents and NSW Government will all play an important role.

There is a diversity of groups in the area with different views and priorities, which can make collaboration challenging. That being said, there is a real appetite from the local leaders to work together with others.

The City could host or facilitate this collaboration. A forum or informal working group could be established and meet on a regular basis to coordinate the projects as we move forward with the revitalisation strategy.

The forum could start with representation from the leaders, champions, chambers and organisations who have been involved to date, and be open to others who want to get involved.

Action considerations

City lead

city planning, engagement
+ city business

Stakeholders and partners

community, groups,
cultural organisations

Timeframe

short term, 0-12 months
ongoing for 3 years

Additional budget

no - resourced with
previous (page 68)



Figure 45

(top) A photo of community leaders meeting in 2005. (bottom) A food vendor as part of Sydney Streets in 2023. Source: City of Sydney.

Potential actions

The following table sets out the 'potential actions' and considers how they help to deliver on the community's vision for Haymarket. This demonstrates that while there is no 'silver bullet', a wide array of actions is needed to respond to all of the community's priorities.

	Respectful of history and celebrates culture	Global, evolving and diverse	Accessible and connected	Authentic, affordable and local	Green, clean and welcoming	Through partnerships and in collaboration
1. Renewal of the heart						
main street improvement program / co-funding grant	x	x		x		x
design guide	x	x		x		x
2. Planning and heritage						
signage and lighting	x	x				x
encourage fine grain renewal	x	x		x		
advocate for transformation of Paddy's market	x		x	x	x	
strengthen heritage	x			x		
advocate restoration of 82-84 Dixon	x	x		x		x
3. Public domain and art						
creative lighting	x	x				
space for events		x	x	x	x	
trees and greening					x	
Campbell Street	x	x	x	x	x	
Belmore Park			x	x	x	

	Respectful of history and celebrates culture	Global, evolving and diverse	Accessible and connected	Authentic, affordable and local	Green, clean and welcoming	Through partnerships and in collaboration
connections into Chinatown		x	x	x	x	
public art	x	x				
cycling connections			x		x	
4. Culture, events and activations						
additional grant funding for activations	x	x	x	x		x
oral histories	x					x
historic interpretation (walk and plaques)	x	x				
long-term support of SXSW Sydney		x	x	x		x
upper storeys and vacant floorspace		x		x		
5. Collaboration and partnerships						
Haymarket coordinator position	x	x		x		x
Haymarket forum	x	x		x		x
advocacy NSW Government assets			x	x		x
Purple Flag accreditation program					x	x

